

# MONOforce

**MONOforce** rappresenta la soluzione ideale ed economica per l'attrezzatura di tutte le macchine utensili in particolare ove sussistano esigenze di precisione e necessità di serraggio utensili sollecitati a elevati carichi torsionali.



Costruito nella versione per mandrini macchina HSK 63 e 100, ISO 26623-1 PSC 63 e 80, nonché DIN 69871 e MAS-BT 40 e 50, permette l'impiego di bussole di riduzione da Ø 12 mm, Ø 20 mm e Ø 32 mm, disponibili in tutta la gamma diametrale compatibile con questi diametri d'alloggiamento per serraggi da Ø 3 mm a Ø 25 mm, anche a TENUTA.



**DIN 69871 AD**

**MAS 403 BT AD**

**DIN 69893 HSK**

**ISO 26623-1 PSC**

MAX.	RPM 15.000
------	------------

MAX.	40 BAR
------	--------

# PORTAUTENSILI A FORTE SERRAGGIO

## DIN 69871 AD

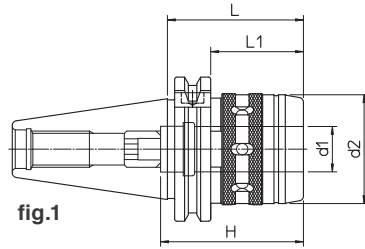

fig.1

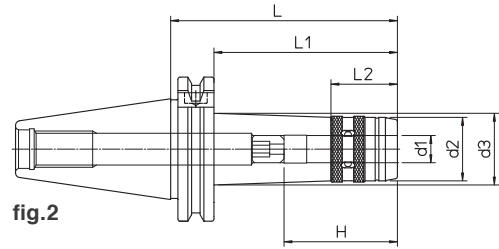

fig.2

Chiave di serraggio esclusa - Predisposizione Chip

DIN	REF.	CODE	d1	d2	d3	H	L	L1	L2	kg	fig.
40	DIN69871-AD40 MF12.50	71DIN-A40MF1205	12	28		46	50	31		0.8	1
40	DIN69871-AD40 MF12.100	71DIN-A40MF1210	12	28	32	46	100	81	29.5	1.2	2
40	DIN69871-AD40 MF20.60	71DIN-A40MF2006	20	48		63	60	41		1.1	1
40	DIN69871-AD40 MF20.100	71DIN-A40MF2010	20	48		63	100	81		1.4	2
40	DIN69871-AD40 MF32.95	71DIN-A40MF3209	32	66		80	95			1.6	1
40	DIN69871-AD40 MF32.140	71DIN-A40MF3214	32	66		80	140			2.0	2
50	DIN69871-AD50 MF20.80	71DIN-A50MF2008	20	48		63	80	61		2.3	1
50	DIN69871-AD50 MF20.125	71DIN-A50MF2012	20	48		63	125	106		2.7	2
50	DIN69871-AD50 MF32.75	71DIN-A50MF3207	32	66		90	75	56		2.8	1
50	DIN69871-AD50 MF32.160	71DIN-A50MF3216	32	66		90	160	141		3.2	2

## MAS 403 BT AD

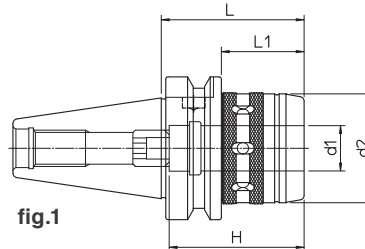

fig.1

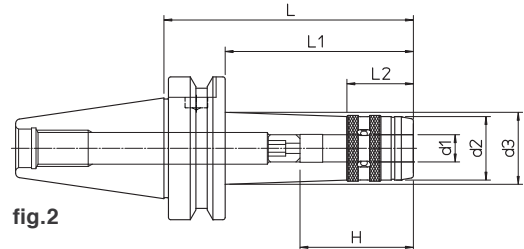

fig.2

Chiave di serraggio esclusa - Predisposizione Chip

BT	REF.	CODE	d1	d2	d3	H	L	L1	L2	kg	fig.
40	MAS403 BT40-AD MF12.60	71MBT-A40MF1206	12	28		46	60	33		0.9	1
40	MAS403 BT40-AD MF12.100	71MBT-A40MF1210	12	28	32	46	100	73	29.5	1.4	2
40	MAS403 BT40-AD MF20.65	71MBT-A40MF2007	20	48		63	65	38		1.3	1
40	MAS403 BT40-AD MF20.100	71MBT-A40MF2010	20	48		63	100	73		1.9	2
40	MAS403 BT40-AD MF32.90	71MBT-A40MF3209	32	66		80	90			2.1	1
40	MAS403 BT40-AD MF32.140	71MBT-A40MF3214	32	66		80	140			3.1	2
50	MAS403 BT50-AD MF20.85	71MBT-A50MF2008	20	48		63	85	47		3.7	1
50	MAS403 BT50-AD MF20.125	71MBT-A50MF2012	20	48		63	125	87		4.1	2
50	MAS403 BT50-AD MF32.95	71MBT-A50MF3209	32	66		90	95	57		4.4	1
50	MAS403 BT50-AD MF32.160	71MBT-A50MF3216	32	66		90	160	122		4.9	2

## MAS 403 BT AD FACE CONTACT

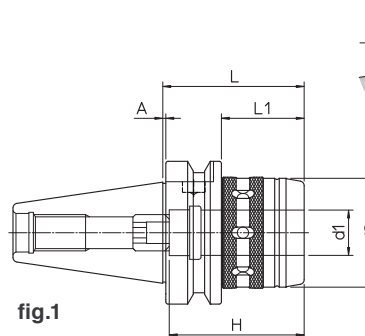

fig.1

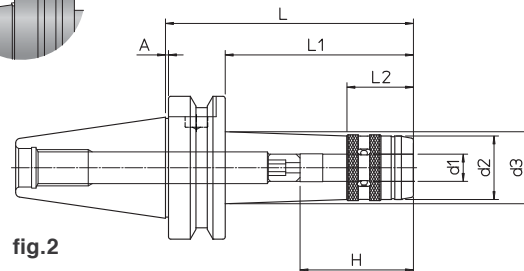
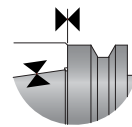
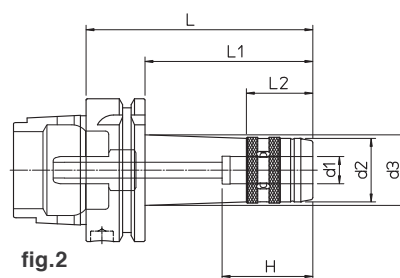
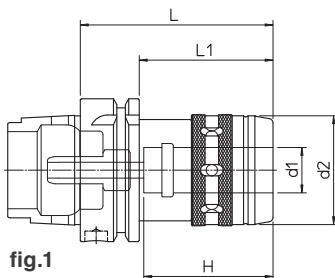

fig.2

Chiave di serraggio esclusa - Predisposizione Chip

BT	REF.	CODE	d1	d2	d3	H	A	L	L1	L2	kg	fig.
40	MAS403 BT40-AD FC MF12.100	71MBF-A40MF1210	12	28	32	46	1	100	73	29.5	1.4	2
40	MAS403 BT40-AD FC MF20.65	71MBF-A40MF2007	20	48		63	1	65	38		1.3	1
40	MAS403 BT40-AD FC MF32.90	71MBF-A40MF3209	32	66		80	1	90			2.1	1
50	MAS403 BT50-AD FC MF20.85	71MBF-A50MF2008	20	48		63	1.5	85	47		3.7	1
50	MAS403 BT50-AD FC MF32.95	71MBF-A50MF3209	32	66		90	1.5	95	57		4.4	1

### DIN 69893 HSK-A



Completo di raccordo per il refrigerante - Chiave di serraggio esclusa - Predisposizione Chip

HSK-A	REF.	CODE	d1	d2	d3	H	L	L1	L2	kg	fig.
63	HSK-A63 MF12.70	71HSK-A63MF1207	12	28		46	70	44		0.8	1
63	HSK-A63 MF12.100	71HSK-A63MF1210	12	28	32	46	100	74	29.5	1.1	2
63	HSK-A63 MF20.85	71HSK-A63MF2008	20	48		60	85	59		1.2	1
63	HSK-A63 MF20.125	71HSK-A63MF2012	20	48		60	125	99		1.7	2
63	HSK-A63 MF32.105	71HSK-A63MF3210	32	66		80	105			2	1
63	HSK-A63 MF32.140	71HSK-A63MF3214	32	66		80	140			2.6	2
100	HSK-A100 MF20.95	71HSKA100MF2009	20	48		60	95	66		2.8	1
100	HSK-A100 MF32.110	71HSKA100MF3211	32	66		80	110	81		3.1	1
100	HSK-A100 MF32.160	71HSKA100MF3216	32	66		80	160	131		3.6	1
125	HSK-A125 MF32.120	71HSKA125MF3212	32	66		80	120	91		5.3	1

### ISO 26623-1 PSC

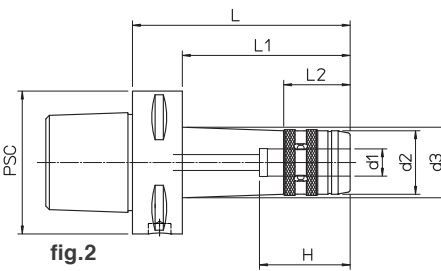
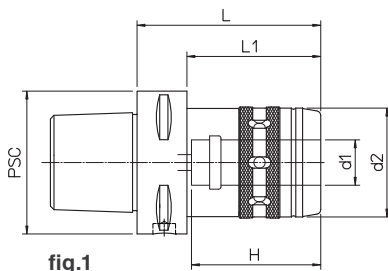

Chiave di serraggio esclusa - Predisposizione Chip

PSC	REF.	CODE	d1	d2	d3	H	L	L1	L2	kg	fig.
63	PSC 63 - MF 12.70	71PSC-063MF1207	12	28		46	70	48		0.9	1
63	PSC 63 - MF 12.100	71PSC-063MF1210	12	28	31.5	46	100	78	29.5	1.4	2
63	PSC 63 - MF 20.80	71PSC-063MF2008	20	48		60	80	58		1.3	1
63	PSC 63 - MF 20.120	71PSC-063MF2012	20	48		60	120	98		1.9	2
63	PSC 63 - MF 32.100	71PSC-063MF3210	32	66		80	100			2.1	1
63	PSC 63 - MF 32.140	71PSC-063MF3214	32	66		80	140			3.1	2
80	PSC 80 - MF 20.80	71PSC-080MF2008	20	48		60	80	50		3.7	1
80	PSC 80 - MF 20.125	71PSC-080MF2012	20	48		60	125	95		4.1	2
80	PSC 80 - MF 32.100	71PSC-080MF3210	32	66		80	100	70		4.4	1
80	PSC 80 - MF 32.160	71PSC-080MF3216	32	66		80	160	130		4.9	2

#### KIT K01

MONOforce 12



1 RC 12.04  
1 RC 12.06  
1 RC 12.08  
1 RC 12.10  
1 CHV 28

#### KIT K01

MONOforce 20



1 RC 20.06  
1 RC 20.08  
1 RC 20.10  
1 RC 20.12  
1 RC 20.16  
1 CHV 50

#### KIT K01

MONOforce 32



1 RC 32.06  
1 RC 32.08  
1 RC 32.10  
1 RC 32.12  
1 RC 32.16  
1 RC 32.20  
1 RC 32.25  
1 CHV 75

A RICHIESTA KIT K01 FACE CONTACT

DIN	REF.	CODE	Kg.
40	KIT K01 MONOFORCE 12.50 DIN40AD	7KDIN-A40MF1205	1.5
40	KIT K01 MONOFORCE 20.60 DIN40AD	7KDIN-A40MF2006	2
40	KIT K01 MONOFORCE 32.95 DIN40AD	7KDIN-A40MF3209	4.4
50	KIT K01 MONOFORCE 20.80 DIN50AD	7KDIN-A50MF2008	4.6
50	KIT K01 MONOFORCE 32.75 DIN50AD	7KDIN-A50MF3207	6.2

BT	REF.	CODE	Kg.
40	KIT K01 MONOFORCE 12.60 BT40AD	7KMBT-A40MF1206	1.5
40	KIT K01 MONOFORCE 20.65 BT40AD	7KMBT-A40MF2007	2.3
40	KIT K01 MONOFORCE 32.90 BT40AD	7KMBT-A40MF3209	4.6
50	KIT K01 MONOFORCE 20.85 BT50AD	7KMBT-A50MF2008	5.4
50	KIT K01 MONOFORCE 32.95 BT50AD	7KMBT-A50MF3209	7.5

HSK-A	REF.	CODE	Kg.
63	KIT K01 MONOFORCE 12.70 HSK63	7KHSA-A63MF1207	1.5
63	KIT K01 MONOFORCE 20.85 HSK63	7KHSA-A63MF2008	2.3
63	KIT K01 MONOFORCE 32.105 HSK63	7KHSA-A63MF3210	4.5
100	KIT K01 MONOFORCE 32.110 HSK100	7KHSA100MF3211	6.7